

PURE

DESIGN BY THORE LASSEN

PRODUCT SHEET



DECEMBER 2020

RANDERS + RADIUS

RANDERS+RADIUS | TOLSAGERVEJ 9 | 8370 HADSTEN | DENMARK | +45 70 30 05 15

PURE CHAIR COLLECTION

With its original design characterized by intuitive and optimum exploitation of the sculptural properties of the pur material, the Pure chair not only offers a carefully developed ergonomic design and functionality, but also an exclusivity not normally seen in this segment.

The pleasantly soft and silky surface on the seat and the back, combined with the inspiring colour choices, transforms the chair into something extraordinary – both in terms of comfort and visual appearance.

“The seat’s carefully selected pattern is not only an aesthetic characteristic, it actually has a functional purpose. It protects the seat of the chair so it doesn’t get any dents, and it also makes the chair more stable when stacked”. Thore Lassen, architect

PRODUCT HIGHLIGHTS

- / Offers perfect ergonomics
- / Soft-touch surface
- / Contributes to good room acoustics
- / The glides have a sound absorbing effect
- / Chairs can easily be linked in rows
- / Pure can stack 12 high
- / Seat and back available in 7 colors
- / Chair suspension possible
- / Easy to clean, withstands disinfection
- / Extremely robust
- / Solution-dyed pur - long lasting colours
- / Danish design produced in Denmark
- / Passed L2 test [extreme use]



DIMENSIONS

PURE CHAIR

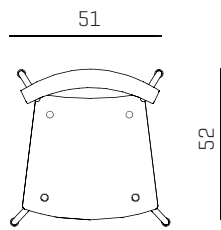
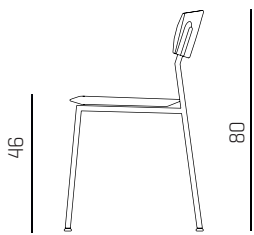

PURE STOOL

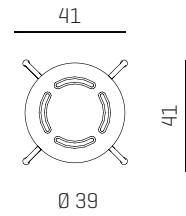
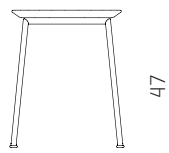

PURE BAR

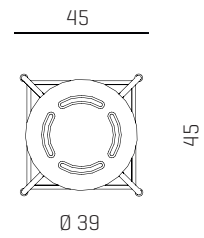
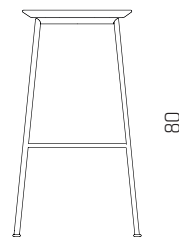
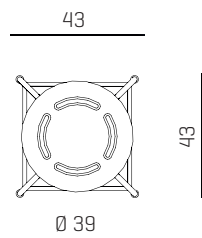
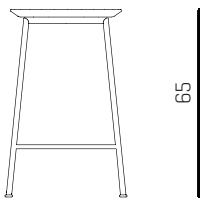

PURE BAR CHAIR

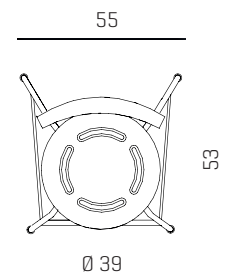
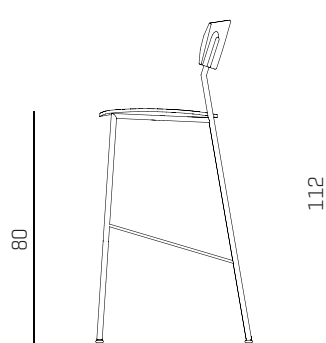
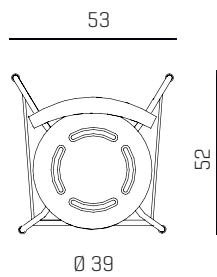
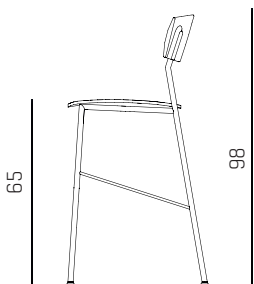

PURE X

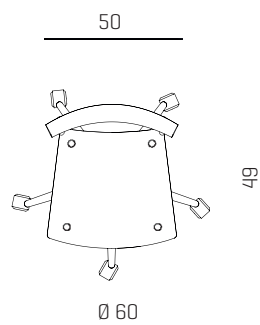
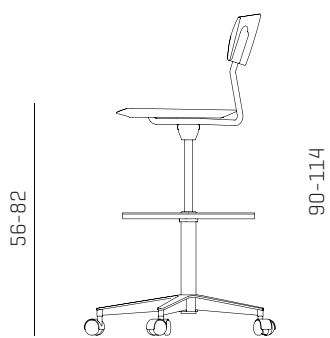

SPECIFICATIONS

Item no.	Model	Description	Depth, cm	Width, cm	Seat height, cm	Height, cm	Weight, kg
P1000	Pure chair	seat/back pur	51	52	46	80	5,5
P1100	Pure chair	upholstered seat, back pur	51	52	46	80	5,7
PT1074	Pure stool	seat pur	41	41	47	47	3,5
PB1075	Pure bar	seat pur	43	43	65	65	4,5
PB1076	Pure bar	seat pur	45	45	80	80	5
PB1275	Pure bar chair	seat/back pur	53	52	65	98	5,5
PB1175	Pure bar chair	back pur, upholstered seat	53	52	65	98	5,7
PB1276	Pure bar chair	seat/back pur	55	53	80	112	7,5
PB1176	Pure bar chair	back pur, upholstered seat	55	53	80	112	7,7
PX1000	Pure X chair	seat/back pur	60	49	44-57	76-89	8
PX1100	Pure X chair	back pur, upholstered seat	60	49	44-57	76-89	8,2
PFX1000	Pure X footrest	seat/back pur	60	49	56-82	90-114	9
PFX1100	Pure X footrest	back pur, upholstered seat	60	39	56-82	90-114	9,2

SEAT / BACK

The seat and back are made of flexible polyurethane [pur] with spring steel integrated in the back. Available in following colours:



Light sandy grey
NCS 2502 Y mat



Sandy grey
NCS 5502Y mat



Black
RAL 9005 mat



Dark petrol
NCS 7010 B10G mat



Dusty olive
RAL 7009 mat



Terracotta
RAL 8002 mat



Warm charcoal
RAL 7022 mat

SEAT UPHOLSTERY

CMHR foam 10 mm. 53 kg/m3 upholstered. All standard fabrics can be recommended. Seat upholstery available for:

P1100	Pure chair
PB1175	Pure bar chair
PB1176	Pure bar chair
PX1100	Pure X chair
PFX 1100	Pure X footrest

FRAME

All-welded tubes Ø19 mm x 1,5 mm precision steel tube DIN 2394. All models available in following colours*:



Light sandy grey
NCS 2502 Y mat



Sandy grey
NCS 5502Y mat

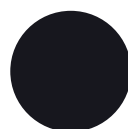

Black
RAL 9005 mat



Dark petrol
NCS 7010 B10G mat



Dusty olive
RAL 7009 mat



Terracotta
RAL 8002 mat

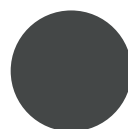

Warm charcoal
RAL 7022 mat



Chrome



Satin chrome

* Pure X: is only available with frame in polished aluminium or aluminium matt black lacquered:



Aluminium



Polished
aluminium

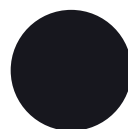

Aluminium
matt black
lacquered

FEATURES / ACCESSORIES

Chair suspension: can be used for Tube, Grip and Sharp bar tables (pls see technical specifications of the tables).

Glides: felt

Linking device: available on P1000 and P1100

Stacking trolley: M1036 can be used for P1000-P1100

Tilt system: available on PX1000, PX1100, PXF1000, PXF1100

XL-gas-lift 50-68cm: available on PX1000, PX1100, PXF1000, PXF1100

Wheels with brakes when not strained: available on PX1000, PX1100, PXF1000, PXF1100

Glides instead of wheels Pure X

STACKING

Dimensions when stacked [examples]

Item no.	Model		Dimensions [L/W/H, cm]
P1000	Pure chair	12 pcs. on the floor	94/50/146
P1100	Pure chair	10 pcs. on the floor	84/50/133
PB1075	Pure bar	2 pcs. on the floor	45/45/83
PB1076	Pure bar	2 pcs. on the floor	49/49/98
PB1175	Pure bar chair	4 pcs. on the floor	74/58/134
PB1176	Pure bar chair	4 pcs. on the floor	74/58/150
PT1074	Pure stool	10 pcs. on the floor	58/58/103

CLEANING AND DISINFECTION

Everyday cleaning: Wipe the chair with a clean damp cloth. If the chair is dirty, dip a cloth in soapy water, wring it out and wipe the chair.

Thorough cleaning: When a more thorough cleaning is required we recommend the white sponge from Miraclean. Just dip the sponge in cold water and carefully rub the mark away.

Disinfection: The pur material can withstand disinfection and you can use ethanol-based disinfectants when cleaning the chair. You can also use Virkon from Dupont.

ENVIRONMENT

Due to the strong pur material, Pure has a long life time.

Pure has a classic design that can be used in many different surroundings.

TEST / CERTIFICATES

L2 [Extreme use]

EN 16139:2013 [Furniture - strength, durability and safety - Requirements for non domestic seating]

Approved for 200 kg. on seat and 70 kg. on back